

TECHNISCHE GEGEVENS

ROLF BENZ 310



**ROLF
BENZ**

- Houten binnenromp
- Nosag veren
- Rug van polyurethaanschuim
- Zitting van polyurethaanschuim, gelaagde opbouw, met verschillende hoogtes en uitvoeringen op elkaar afgestemd
- Bekleding onderzijde, met polyestervlies
- Beugelpoot naar keuze:
 - roestvrij staal
 - Staal glad, gepoedercoat mat RAL 9017 verkeerszwart

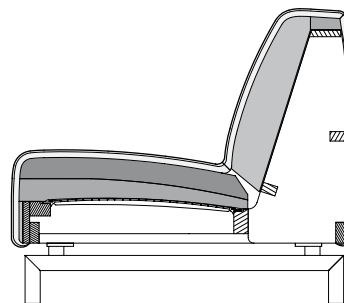

! Ploovorming en zitafdrücken zijn vanwege comfort- en designredenen ook bij hoogwaardige gestoffeerde meubels van Rolf Benz niet te vermijden. Alle afmetingen zijn bij benadering.

Zithoogtes leverbaar

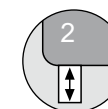

Bank

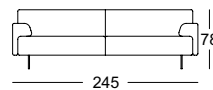
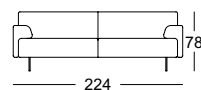
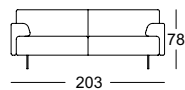
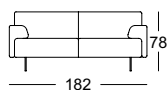

**ROLF
BENZ**

Aanbouwbank*

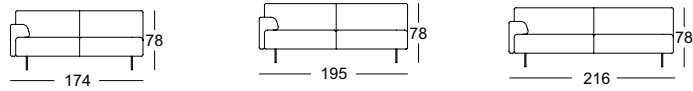

Hoek-aanbouwbank*

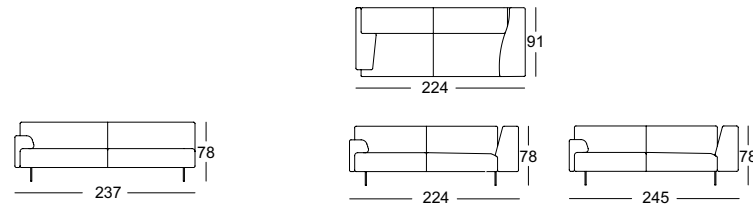

Hoek-aanbouwbank*

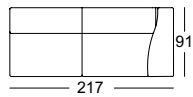

Aanbouwbank met zitting*

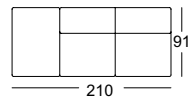

Hoek-aanbouwbank met zitting*

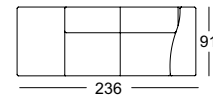

Voetenbank groot

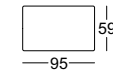

Voetenbankje

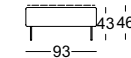
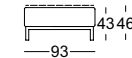
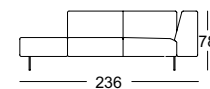
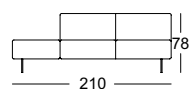
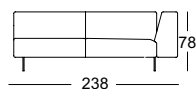
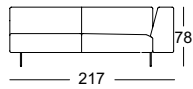

Combinatie voorbeelden:

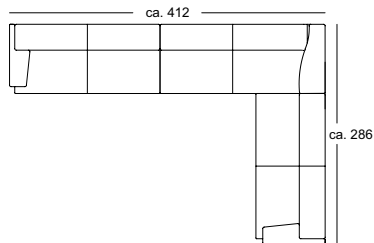

ASO 310/195 li.
E-ARB 310/217 li.
ASO 310/195 re.

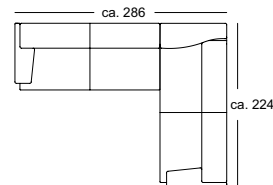

ASO 310/195 li.
E-ASO 310/224 re.

*Deze elementen zijn als linker uitvoering afgebeeld, ze zijn echter ook in spiegelbeeld, in de rechter uitvoering leverbaar.